

Uncle Ted's Guide To Communications Cabling

Contents

Jargon
Overview of Structured Cabling
Cables
Terminations
Installation
Testing
Wrapup, Training Programs and Equipment

The Fiber Optic Association Inc.

www.foa.org

info@foa.org



Welcome to Uncle Ted's guide to voice/data/video cabling, the printable version of the Uncle Ted's Guide on the web @ <http://www.vdvworks.com/UncleTed/>.

Uncle Ted was the mascot of Cable U's training programs about wiring, focusing on Cat 3/5/5e/6/6A UTP cabling. He's [Lennie Lightwave's](#) Uncle and the expert on premises wiring.

Uncle Ted's Guide is an overview of what you need to know to get started in installing premises cabling, voice/data/video cabling, low voltage or communications wiring, structured cabling or whatever you call it. (Turns out the terminology is not standard, perhaps the only thing that isn't!)

After reading Uncle Ted's Guide, you might be interested in the FOA textbooks, *The FOA Reference Guide to Premises Cabling* and *The FOA Online Reference Guide with its section on Premises Cabling*.

Also, check out FOA's free online training site Fiber U where there is a free online self-study program on premises cabling as well as many other topics on cabling.

And be sure to let us know how you like this guide and how we can improve it in the future . Email us at info@foa.org

Uncle Ted's Guide is also available as a free eBook on iTunes.

If you like *Uncle Ted's Guide* you'll love *Lennie Lightwave's Guide To Fiber Optics!*

Uncle Ted's Guide To VDV Cabling

Cabling Jargon

It helps to know the language so here's an overview of the basic jargon used in cabling and we'll explain more as we go along.

To begin with, what do we call this whole area of cabling?

People call it lots of things: VDV (for voice/data/video), data/voice, low voltage, limited energy, teledata, datacom, premises cabling, but most call it "structured cabling" after the "TIA 568" standard. It's the infrastructure for telephone and LAN connections in most commercial installations and even in some modern homes. It's also used for fire alarms, building management, audio and video.

Structured Cabling: An architecture for communications cabling specified by the EIA/TIA TR42 committee and used as a voluntary standard by manufacturers to insure interoperability.

Standards

Structured cabling is based on a number of industry standards - voluntary standards - developed by manufacturers who want their products to interoperate - work together. They meet in committees several times a year and decide on the specifications of their products. These common specs mean that equipment will work on any cabling system that follows the standards and most cabling components can be interchanged without adversely affecting performance.

Standards Groups: EIA/TIA: Electronics Industry Alliance/Telecommunications Industry Assn, an industry trade association that creates voluntary interoperability standards for the products made by member companies. **ISO/IEC:** International Standards Organization/International Electrotechnical Commission.

EIA/TIA 568: The main standard document for structured cabling, usually referred to as simply "568." It is now on the "C" revision which includes sections for general specifications and individual sections for copper and fiber optics. Internationally, its equivalent is ISO/IEC 11801.

EIA/TIA 569: Covers pathways and spaces. Defines the "telecom closet" or telecom room as it is now called. ISO/IEC 14763-2.

EIA/TIA 570: For residential cabling.

EIA/TIA 606: cabling system administration (documentation), ISO/IEC 14763-1

EIA/TIA 607: Grounding and bonding

International Standards

The international equivalent of EIA/TIA 568 is ISO/IEC 11801. The standards are written similarly to what has been done by TR 42. Here are their relevant standards:

ISO/IEC 11801 - Cabling for customer premises - structured cabling similar to TIA 568

ISO/IEC 14763-1 - Administration, documentation - similar to TIA 606

ISO/IEC 14763-2 - Planning and Installation - similar to TIA 569

Uncle Ted's Guide To VDV Cabling

ISO/IEC 14763-3 - Testing optical fibre cabling - included in TIA 568

IEC 61935-1 - Testing copper cabling - included in TIA 568

Standards are not code! They are voluntary interoperability specifications. However every installation must be compliant to local building codes for safety! **NEC (National Electrical Code, US):** written by NFPA (National Fire Protection Assn.) is the code that sets standards for fire protection for construction and is a legal requirement in most cities.

Structured Cabling Architecture

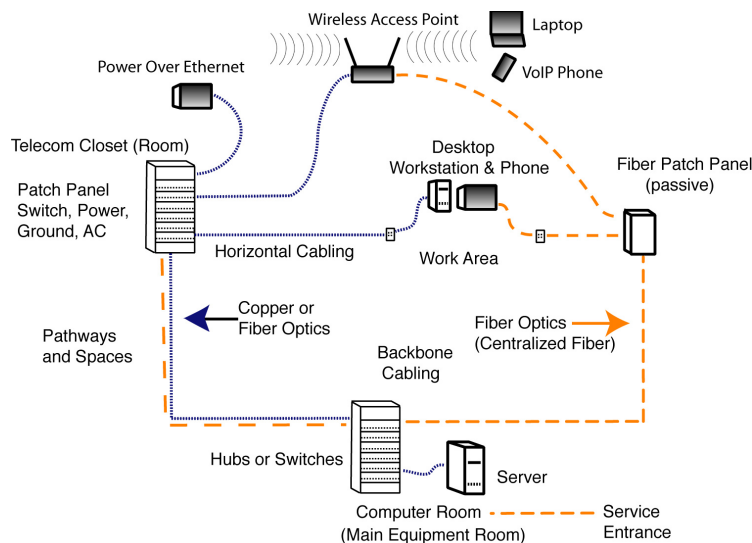

Structured Cabling Terms

Telecom Closet (TC): The location of the connection between horizontal cabling to the backbone. Now often called "Telecom Room" to imply it's usually bigger than a closet!

Main Cross-Connect (MXC): The old telco term for the location of the main electronics in a building. LAN people may call it the equipment room

Intermediate Cross-Connect (IXC) : A room in between the TC and MXC where cables are terminated

Work Area Outlet: The jack on the wall which is connected to the desktop computer by a patchcord

Patch Panel: A rack or box where cables are terminated - usually in 110 punchdowns and interconnected with patchcords

Horizontal Cabling: The connection from the telecom closet to the work area outlet (desktop)

Backbone Cabling: The cabling that connects all the hubs in telecom closets or MXCs together

Link: The installed cable plant from work area outlet jack to the patch panel in the telecom closet

Channel: The cable plant including the link plus patchcords on either end to connect the communications hardware

Uncle Ted's Guide To VDV Cabling

Patchcord: A short length of stranded cable with a RJ-45 plug on either end, used to connect hardware to the link or to connect cables in a Patch Panel

J hook: A hook shaped like the letter J used to suspend cables

Fishtape: Semiflexible rod used to retrieve cables or pull line

Cable

The Types Of "Low Voltage" Cable.

UTP: Unshielded twisted pair cable, comprised of 4 twisted pairs of copper conductors, graded for bandwidth as "Levels" (from Anixter) or "Categories" (EIA/TIA 568)

Category 3,4,5, 5e, 6, 6A: Ratings on the bandwidth performance of UTP cable, derived from Anixter's Levels program. Cat 5e (enhanced) is rated to 100MHz. Cat 6A standards for UTP at up to 500 MHz. Cat 7 is being discussed for the future. ISO/IEC standards are C (Cat 3), D (Cat 5e), E/EA (Cat 6/Cat 6A) and F.

A typical Cat 6 UTP cable is shown below.

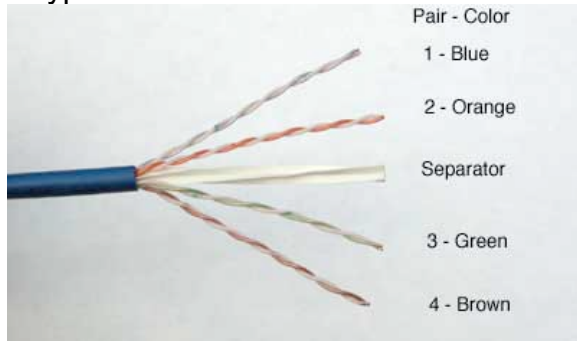

STP: Shielded twisted pair, specified by IBM for Token Ring networks

Optical Fiber: Both multimode and singlemode fiber are included in structured cabling standards as well. See [Lennie Lightwave's Guide to Fiber Optics](#) for more information on fiber optics.

Coax: A type of cable that uses a central conductor, insulation, outer conductor/shield, and jacket; used for high frequency communications like **CCTV** (closed circuit TV) or **CATV** (community antenna TV or cable TV). *Coax is not included in 568 but is included in 570 for home use*

RG-6/RG-59: 75 ohm coax used for video. RG-6 is the standard for CATV, RG-59 is used on some short CCTV networks.

RG-58: 50 ohm coax used for "Thinnet" Ethernet.

HFC: Hybrid fiber-coax CATV network combines coax and optical fiber

Terminations

The connectors for UTP are also standard - used on every cable for Cat 3, 5, 5e, 6, 6A, but must be rated for the same performance level, e.g. Cat 6 hardware on Cat 6 cable in order to preserve the performance rating of the cabling system.

RJ-45: The popular name of the modular 8 pin connector

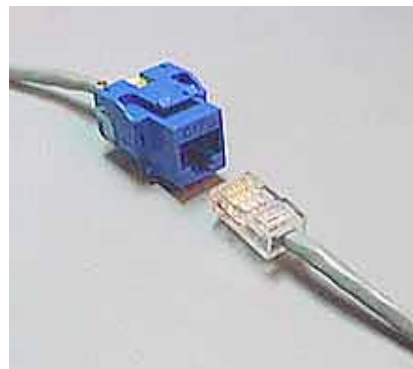

Uncle Ted's Guide To VDV Cabling

used with UTP cable in structured cabling systems. (*Technically a RJ-45 is a connector with USOC connections for POTS – plain old telephone service, but everybody calls the TIA connector an RJ-45 anyway.*)

Jack: The receptacle for a RJ-45 Plug.

Plug: The connector put on the end of UTP cable.

Punchdown: A connecting block that terminates two cables directly. 110 blocks are most popular for LANs, 66 blocks for telco, but some installers use BIX or Krone.

Below - 66 blocks on the left, 110 blocks on the right:

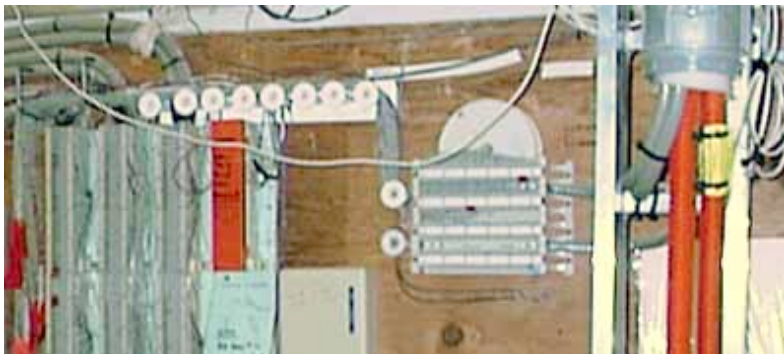

Testing

After installing the cables, every one must be tested. Every cable, including Cat 3 for telephones, must be tested for wiremap, but cable certifiers will test for all the parameters listed below.

Wiremap: All eight wires must be connected to the correct pins, and the test is called a wiremap test.

Length: The length must be less than 90 m for the permanent link and less than 100 m for the channel

Attenuation: The reduction in signal strength due to loss in the cable.

NEXT: Near End Cross Talk, or the signal coupled from one pair to another in UTP cable.

ACR: Attenuation to crosstalk ratio, a measure of how much more signal than noise exists in the link, by comparing the attenuated signal from one pair at the receiver to the crosstalk induced in the same pair

Return Loss: Reflection from an impedance mismatch in a copper cable

ELFEXT: Equal level far end crosstalk; crosstalk at the far end with signals of equal level being transmitted.

Alien Crosstalk: Coupled signal from a given pair in one cable to the same pair in another cable.

Propagation Delay: The time it takes a signal to go down the cable.

DC Loop Resistance: The DC resistance of the cable in ohms.

Delay Skew: The maximum difference of propagation time in all pairs of a cable.

Power Sum Next: Near end crosstalk tested with all pairs but one energized to find the

Uncle Ted's Guide To VDV Cabling

total amount of crosstalk caused by simultaneous use of all pairs for communication

Power Sum ELFEXT: ELFEXT for the sum of the other 3 pairs on the 4th pair.

PSACR: PowerSum ACR

Then There's The Electronics That Makes It All Work Over The Cabling As A Network:

Hub: The electronic box that connects to all the horizontal cables which are then connected by backbone cabling, enabling any PC to talk to any other

Switch: A device like a hub but connects any two devices directly, allowing multiple connections simultaneously

Bridge: A device that connects two or more sets of network wires

Router: A smart switch that connects to the outside world

Ethernet:: A 10, 100 or 1000 Megabit per second local area network (LAN) that is by far the most popular LAN

10Base-T: 10 MB/s Base Band Transmission, 100 meters max, segment length on Cat 3, or better twisted pair cable

100Base-TX: 100 MB/s Base Band Transmission, 100 meters max, segment length on Cat 5, twisted-pair cable, also referred to as Fast Ethernet

1000Base-T: Gigabit Ethernet on Cat 5e UTP

Power over Ethernet: The IEEE 802.3 Ethernet committee added provisions for powering devices off the spare pairs in a 4-pair UTP cable. Since Ethernet up to 100Base-TX uses only pairs 2 and 3, pairs 1 and 4 are available to provide power. Pair 1 (pins 4/5) is the + conductor, pair 4 (pins 7/8) is the - conductor. Two versions exist – 13 or 25 watts of power are available, adequate for powering local switches or hubs that can serve several users locally from one UTP cable, thus saving cabling costs.

All versions of Ethernet also have fiber optic connection standards.

Test Equipment and Tools:

Digital multimeter: A simple tester that measures if the cable is shorted and whether or not it is open

Wire Mapper: Checks each wire to make sure they are terminated in the correct order

Cable Certification Tester: Tests everything, wiremap, length, attenuation and crosstalk in one connection, gives you a pass/fail result

Cable Verification Tester: A tester that uses network protocols to test whether the cabling will transmit data reliably.

TDR: Time domain reflectometer, a testing device used for copper cable that operates like radar to find length, shorts or opens, and impedance mismatches

Uncle Ted's Guide To VDV Cabling

Structured Cabling for Communications - An Overview

A Little History....

The history of telecommunications spans a mere 150 years, starting with the development of the telegraph in the early 19th century. Telegraphy gave man the means to transmit impulses that represent letters. When these letters were received and decoded, they provided a way to convey messages over long distances.

Naturally, the next step was to consider whether sound might also somehow be electrically transmitted. Alexander Graham Bell applied for his patent for an "electrical speaking telephone" in 1876. In reality, many men contributed to telephone improvements including David Edward Hughes whose invention of the microphone became universally used in telephones.

It is amazing how quickly the use of the telephone spread. The first switchboard, an experiment, was installed in Boston in 1877. Just four years later, there were 54,000 telephones in the United States! In the first decade of the 20th century, Dr. Lee deForest's invention of the vacuum tube amplifier enabled long distance communications.

By the 1970s, integrated circuit technology and the microprocessor began to influence telecommunications and computers. Experiments began in digital voice transmission and fiber optics. Computer networks like Ethernet and the predecessor of the Internet were developed.

The 1980s brought wide scale use of digital telecom, computer networks and fiber optics, but was also the era of the breakup of the Bell system. Users who once depended on AT&T for telecom standards and IBM or other computer companies for the "rules" they depended on were left stranded.

Manufacturers took up standards development to insure interoperability of their products - under the auspices of the IEEE for computer networking electronics and EIA/TIA for cabling. Thus was born the industry standards that we all depend on for today's communications networks.

Mandatory or Voluntary Standards?

Widespread usage of any technology depends on the existence of acceptable standards. The most important standard and the only one that is mandatory is the National Electrical Code developed by the National Fire Protection Assn. that covers all aspects of electrical safety. Article 800 of the NEC covers communication circuits, such as telephone systems and outside wiring for fire and burglar alarm systems and Article 770 covers fiber optics. Also, all VDV wiring must comply with building and electrical codes applicable in your state or city.

But during the 1980s, phone signals became digital, LANs proliferated and new cables and cabling architecture were needed. The goal was to make buildings "smart," able to allow computer and phone conversations over a standardized wiring system. By the early 90s, a scheme of "structured cabling" was standardized by technical committee of a trade association, the merged Electronic Industries Association and Telecommunications Industry Association (hereafter referred to as EIA/TIA).

Uncle Ted's Guide To VDV Cabling

Just to confuse everybody, this cabling standard, developed by the EIA/TIA TR 41.8 committee - now renamed TR 42, is referred to by the number of the primary standard, EIA/TIA 568, although there are actually a number of standards, technical advisories, etc. that cover all aspects of structured cabling. We'll go along with the crowd and simply say "568" when we generally mean the entire output of the TR 42 committee! And to further confuse everybody, many people think this standard is a mandatory, even legal, document like the NEC. NO WAY! "568" is a *voluntary interoperability standard* for communications cabling, developed by a number of manufacturers of cabling components and networking equipment, so that they might make equipment that could use any 568-compliant cabling system and be upgraded in the future as long as it was designed for the same cable plant.

What 568 is, in fact, is a common sense approach to cabling that offers interoperability, upgradability and low cost due to the numerous manufacturers offering compatible products. But it ain't code!

Note: 568 is a US standard. Overseas, ISO/IEC writes the standards and a summary of their standards is below.

The Basics of "568"

"568" calls for connecting the desktop (work area) to a telecom closet (the "horizontal" run) with up to 100 meters of cable (including no more than 10 m total of patchcords), which is usually Cat 3, Cat 5 or Cat5e UTP. The "Cat" or category designation refers to a performance grade, which we will explain later. Most copper installations today use Cat 5e or Cat 6 exclusively, as it isn't that much more expensive than Cat 3 and can support phones or any LAN on any outlet.

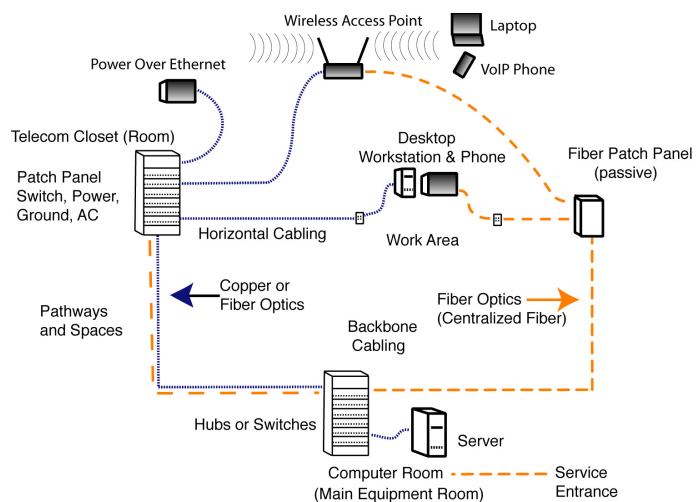

The backbone cabling can be either UTP or fiber optics. In larger networks, fiber is most often used for its longer distance capability and higher bandwidth. 568 specifies two multimode fibers, 62.5/125 – once the most common MM fiber that has been replaced in recent history by 50/125 - a higher bandwidth fiber rated for use with lasers for gigabit networks. Singlemode fiber is also specified for longer links, as in a campus, for high speed networks.

Fiber optics is also a horizontal option in 568, but not often used because of the higher cost except where high bitrate networks or future upgrades are expected. However, a properly designed centralized fiber network does not need a telecom closet and saves the cost of conditioned power, data ground, AC and the floor space, which may offset the additional cost of the fiber electronics. A version of fiber to the home PON (passive optical network) has also been used in LANs.

Uncle Ted's Guide To VDV Cabling

The telecom closet houses the hubs for the computers in the work areas. These hubs are interconnected on "backbone" wiring which is mostly fiber optics, as it usually carries higher speed signals over longer distances and provides isolation from ground loops, another bugaboo of LANs. The main cross-connect (MXC) or equipment room contains the network and telco hardware. For the telephones, their lower bandwidth requirements allow longer runs, so they are usually simply connected to backbone cables in the telecom closet with a punchdown and run straight to the MXC.

568 also includes IBM Type 1 cable, a shielded two pair cable, since it is still used in some networks. However, it ignores coax cable, like RG-58 used in some Ethernet LANs and RG-6 used in CATV and CCTV.

Beyond 568

568 is only part of the structured cabling standards. It's a multi-part standard itself and there are several more standards cover other areas of cabling:

EIA/TIA 568: The main standard document for structured cabling, usually referred to as simply "568." It is now on the "B" revision and includes sections for general specifications (B.1) and individual sections for copper (B.2) and fiber optics (B.3)

EIA/TIA 569 A: Covers pathways and spaces. Defines the "telecom closet" or telecom room as it is now called.

EIA/TIA 570 A: For residential cabling.

EIA/TIA 606: Cabling system administration (documentation)

EIA/TIA 607: Grounding and bonding

International Standards

The international equivalent of EIA/TIA 568 is ISO/IEC 11801. The standards are written similarly to what has been done by TR 42. Here are their relevant standards:

ISO/IEC 11801 - Cabling for customer premises

ISO/IEC 14763-1 - Administration, documentation

ISO/IEC 14763-2 - Planning and Installation

ISO/IEC 14763-3 - Testing optical fibre cabling

IEC 61935-1 - Testing copper cabling

Learning More About Standards

There are a number of ways of finding out more about these cabling standards. Since the standards are written for manufacturers, not installers or users, manufacturers always have good educational materials on their website or in their catalogs on the parts of the standards important to you. Or you can buy a complete copy of the EIA/TIA or ISO/IEC standards from [Global Engineering Documents](#) for a lot of money and wade through the strange standards language.

Uncle Ted's Guide To VDV Cabling

The Cabling

The choice of network cabling (or communication medium as it is sometimes called) is rather important because of the extremely high frequencies of the signals. Sending a 60-cycle utility power through a wire rarely presents a difficulty; but sending a billion bits per second signal can be a little more tricky. For this reason, the method of sending signals and the materials they are sent through can be important.

Network Cabling Types

A number of cabling options are available for networking connections.

Unshielded Twisted pair (UTP) - UTP cable is the primary cable used for networks, as specified in the EIA/TIA 568 standard. This cable type has been widely used because it is inexpensive and simple to install. Limited bandwidth (which translates into slower transmissions) has pushed development of new cable grades (the "categories" of 568) but has created a more expensive product and more complicated installation process.

Screened Twisted pair (ScTP) - Same as UTP with an overall shield around the 4 pairs. While not currently specified for any networks or covered in the EIA/TIA 568 standard, it is used in many networks in Europe where EMI is a greater concern. It tends to be more expensive, harder to terminate and requires special plugs and jacks.

Shielded Twisted Pair (STP) - Like UTP but with a shield around every pair. Widely used in IBM systems (IBM Type 1 cable) and included in 568.

Coaxial Cables - Original Ethernet, used in CATV systems. This is familiar and easy to install, has good bandwidth and lower attenuation but more expensive, bulky. Not included in 568, but in 570 for residential use.

Optical Fiber - Optional for most networks, top performance, excellent bandwidth, very long life span, excellent security but slightly higher installed cost than twisted pair cables, more expensive electronics interface to them. Cost effective with optimal architecture. See *Lennie Lightwave's Guide To Fiber Optics*.

Other transmission options:

Wireless (WiFi or cellular) has become a mandatory part of every premises cabling network as users with laptops, tablets and phones want to be mobile. No data transmission cables are required to connect any individual terminal, but wireless requires cabling to every access point (antenna,) so it's hardly "wireless"! Within the range of the radio signals, a mobile device can be moved anywhere.

Infrared Transmission - Also transmits without wires to the terminal by using infrared (IR) light but each transmitter requires cabling. By sending pulses of infrared light in the same patterns as electronic pulses sent over cables, it is possible to send data from one place to another. Networks based on IR transmission have been developed for use in office and for line-of-sight transmissions between buildings but are extremely rare.

Powerline or Phone Line Transmission - Networks using available cabling with mixed results.

Uncle Ted's Guide To VDV Cabling

Unshielded Twisted Pair

Because networking evolved over several decades, many different cabling solutions have been used. But today, virtually all VDV copper cabling has moved to unshielded twisted pair (UTP) as specified in the EIA/TIA 568 standard because it has been inexpensive, may already be in place, is familiar to installers and is simple to install. (The cost and simplicity of installation has changed a bit, however, with Cat 6, see below.)

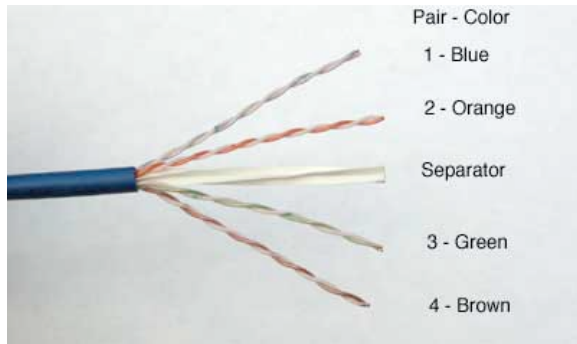

UTP cable is comprised of four pairs of carefully twisted pairs of copper wire, insulated with carefully chosen material to provide high bandwidth, low attenuation and crosstalk. UTP cable works so well because it is used with transmitters that work on "balanced transmission." They transmit equal but opposite signals on each wire of the pair so each wire has only half the amplitude of the final signal. The electrical and magnetic fields of each wire are opposite and cancel out each other, producing low electromagnetic emissions. Likewise, electromagnetic pickup is the same on both wires so they cancel out.

We'll say it here and many times more before we're through - the secret ingredient of Cat 5e/6/6A is the twists! In order to maintain Cat 5e/6/6A performance, especially crosstalk, you absolutely must keep the twists as close as possible to the terminations! The cable is terminated mostly in jacks, connector receptacles that have punchdown terminations on the backside and tricks inside to prevent crosstalk. [See Terminations.](#) Some snap into work area outlets, others are incorporated in rack mount patch panels. 568 allows many possible cable configurations, including intermediate punchdowns, but a direct run from a work area outlet to a patch panel will provide the highest performance, likely necessary if upgrades to fast networks like Gigabit Ethernet are contemplated.

Patchcords for connecting network equipment to the outlet or patchpanel are usually purchased factory-assembled. The connector (plug) is properly called a "modular 8 pin" but usually is referred to as a RJ-45, which is actually a specific telco use of the same plug. They use stranded cable for flexibility and require special connectors. Order them to proper length if you can to prevent the mess that patch panels often become after a few moves and changes.

Right now, you can get hardware and cable rated for Cat 3, Cat 5e or Cat 6. With cable, it's easy to see the difference; it's in the twists - higher performance cables have more twists. But jacks are harder to tell the differences. Trust us - they are different. If you

Uncle Ted's Guide To VDV Cabling

terminate Cat 5e cable with Cat 3 jacks, you will get Cat 3 performance - no better!
 When dealing with Category 5e and the newly ratified Cat 6 designed to support Gigabit Ethernet, termination procedures become even more complicated!
 Instead of the "Categories" used in the US, in Europe and much of the rest of the world they use "Classes" to designate performance. Here's a table of performance and correlations to US standards.

ISO/IEC Class	US Category	Frequency (MHz)
A		0.1
B		1
C	3	16
D	5e	100
E	6	250
F	7	600 (Not currently under consideration in the USA)

Below is a table describing cable characteristics

Cable Performance (By Category For UTP)

Characteristic EIA/TIA(ISO)	Cat 5	Cat 5e (Class D)	Cat 6 (6A) (Class E/EA) (Ratified 6/02)	Cat7 (Class F) (ISO proposal)	Fiber Optics
Supports networks	100Base-T	1000Base-T	1000Base-T (with more "headroom") 1000Base-TX	? None currently considered	10GBase-T and other networks at up to 10 gigabits per second
Test Frequency	100 MHz	100MHz	250 (500) MHz	600 MHz	Terahertz
Length	100 meters	100 meters	100 meters	100 meters	250m to 2km (MM) >20 km (SM)
RJ-45 Compatible	yes	yes	yes	No	NA
Field Tester Requirement:	Level 2	Level 2e	Level 3	Unknown	Optical Loss Test Set

Future Enhancements

Like everything else that deals with computers and communications, the speed keeps going up. When Cat 5 was marginal to handle newer networks, the EIA/TIA TR 42 committee that writes the cabling standards (the same "568" we referred to earlier) created the standard for Cat 5e (enhanced), Cat 6 cabling and then Cat 6A (augmented), each after years of debate, discussion and testing.

A cabling standard includes cables, plugs and jack, patch panels and patch cords, in other words, everything you need to install a complete cabling system. Performance

Uncle Ted's Guide To VDV Cabling

specifications for Cat 6A are for significant advances over Cat 5 - with attenuation and crosstalk performance almost as good at 500MHz as Cat5e at 100 MHz. The result is that the attenuation of a Cat 6A link at 100 MHz is about 40% less than Cat 5e and crosstalk (NEXT) is almost 10 times better.

So using Cat 6A will give you more "headroom" - better signal to noise ratios - which can mean more robust data transmission on Fast Ethernet and Gigabit Ethernet (1000base-T) networks, and is mandatory for 10Gb networks.

But this leap in technological advances came with a cost. The goal of the committee was that each new performance grade be "backward compatible" which means that any networking product that works on Cat 3, 5 or 5e is supposed to work on Cat 6A. The other issue that the group wrestled with was "interoperability" - mixing and matching components. This part of the standard states that cable plant containing mixed categories (eg: Cat 5e patchcords on a Cat 6 cabling systems) is supposed to work without compatibility issues, but will only work at the level of the minimum component specification (Cat 5e in this case).

Sometimes there is the issue of compatibility among different manufacturers products. Practically everybody told users installing "pre-standard" Cat 6 to stick to one manufacturer's products or those tested for compatibility. Even the EIA/TIA press release on the Cat 6 standard stated: "To ensure generic cabling system performance, Category 6 component requirements are specified to be interoperable when products from different manufacturers are mated". The word from insiders, however, is that there are some details still to be ironed out. Be careful when being an „early adopter.”

Network Cable Handling

The performance of the cabling network is heavily dependent on the installation. The components used in structured cabling installation have been carefully designed and exhaustively tested to meet or exceed the requirements of EIA/TIA 568 for performance at 100 MHz. If the cable is not properly installed, performance will be degraded. See the section on installation for more tips.

Termination

UTP cables are terminated with standard connectors (plugs and jacks) or punchdowns. The plug/jack is often referred to as a "RJ-45" (see jargon), but that is really a telco designation for the "modular 8 pin connector" terminated with a USOC pinout used for telephones. The male connector on the end of a patchcord is called a "plug" and the receptacle on the wall outlet is a "jack." These terminations are called "IDC" for "insulation-displacement connections," by the way, since the wires are held in knife-edge terminations that slice through the insulation and dig into the copper wire, forming a tight seal.

In LANs, as spec'ed by 568, there are two possible pinouts, called T568A and T568B

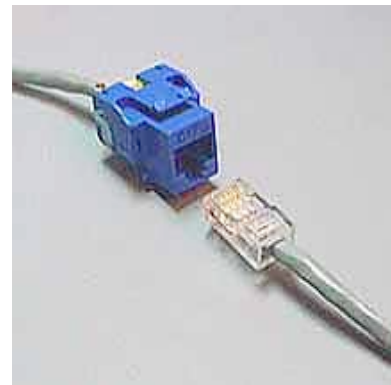

Uncle Ted's Guide To VDV Cabling

that differ only in which color coded pairs are connected - pair 2 and 3 are reversed. Either work equally well, as long as you don't mix them! If you always use only one version, you're OK, but if you mix A and B in a cable run, you will get crossed pairs! The cable pairs are color coded as shown in the cable section (page 13.) Each pair consists of a colored wire and a white wire with a matching color stripe. The stripe wire is "tip" and the solid color wire is "ring," referring to the tip of the old 1/4" telephone plug and the ring around the shaft that makes the connections. Note: Plugs/jacks and punchdowns have different color codes! You cannot mix them up as they will result in wiremap errors - esp. split pairs which cause big problems with high speed transmission.

Jacks: The jacks are then terminated with these layouts, looking into the jack:

Note that the only difference between T568A and T568B is the reversal of pairs 2 and 3 - it's only a color code change. Jacks usually have 110-style punchdowns on the back which can be terminated with punchdown tools, using special manufacturer's tools or even a snap-on cover for the connector. Again, you **MUST** keep the twists as close to the receptacle as possible to minimize crosstalk.

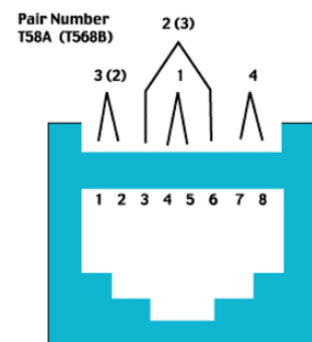

The color codes are going to look like this for these jacks.

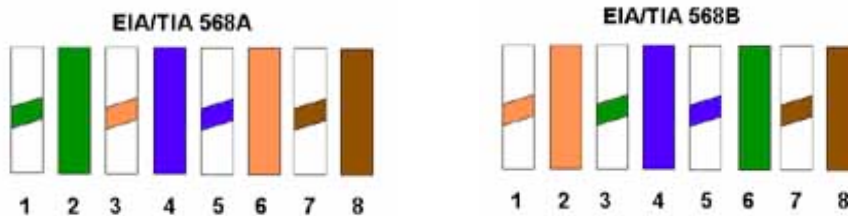

Note: Cat 3 jacks and all plugs are going to use these color codes shown above. However, Cat 5, 5e, 6 and 6A jacks have internal connections that continue the twists as close to the pins in the jacks as possible. Thus the pinout on the back of the jacks will not usually follow the standard color code layouts- see the pin sequence in the photo above and the twists in the internal connections of the jack here!

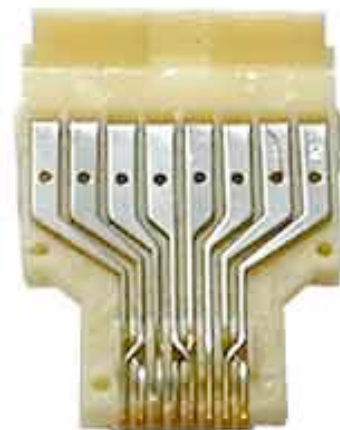

Remember: Always follow the color codes on the back of the jacks to insure proper connections!

Uncle Ted's Guide To VDV Cabling

Plugs: The plugs are terminated by straightening out the wires in proper order and crimping on a connector. Like we said before, you **MUST** keep the twists as close to the plug as possible to minimize crosstalk.

Patchcords: They generally use stranded wire for flexibility but can be made with solid wire for higher performance. Note that plugs may be different for each type of wire, so make sure you have the right type.

Crossover Cables: Normal cables that connect a PC/NIC card to a Hub are wired straight through. That is pin 1 is connected to pin 1, pin 2 to pin 2, etc. However, if you are simply connecting two PCs together without a hub, you need to use a crossover cable made by reversing pair 2 and 3 in the cable, the two pairs used for transmission by Ethernet. The easy way to make a crossover cable is to make one end to T568A color coding and the other end to T568B. Then the pairs will be reversed.

Punchdowns

Sometimes there are cross connects using punchdowns in the telecom closet, more common on telephone wires than data. These are called punchdowns because the cable is punched down into the IDC contacts with a special tool, called (surprise!) a punchdown tool. Of course, you **MUST** keep the twists as close to the punchdown as possible to minimize crosstalk.

Punchdowns come in 4 varieties: 110, 66, Bix and Krone. Most popular for LANs is the 110, for telcos it's the 66, and the Bix and Krone are rare (price, proprietary designs, etc.) Below: 110 block on the left, 66 block on the right.

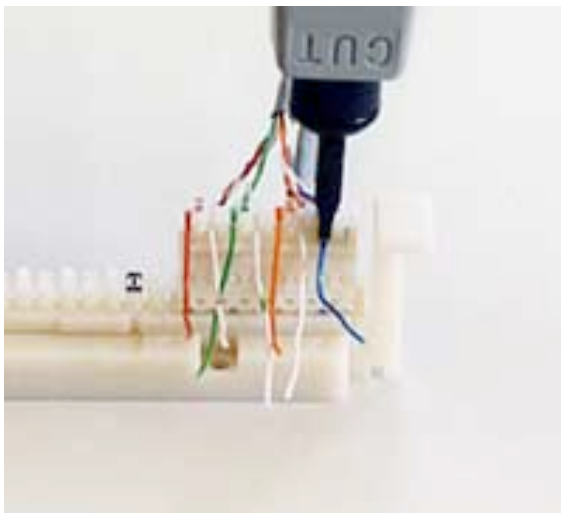

Color Codes For Punchdowns:

Punchdowns of all types are always made with the pairs in order with the white/stripe wire (tip) first, then the solid colored wire (ring).

Pair 1(w/blue-blue)

Uncle Ted's Guide To VDV Cabling

Pair 2 (w/orange-orange)
Pair 3 (w/green-green)
Pair 4 (w/brown-brown)

*(This color code is often remembered by **BLOG** - **BL**ue**O**range**G**reen and brown is all that's left!)*

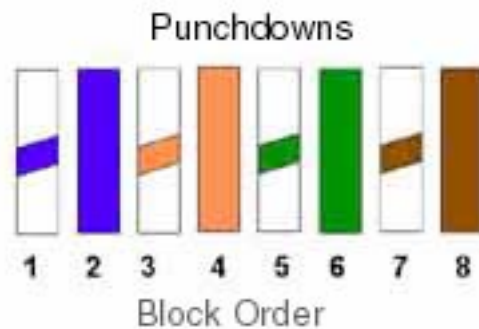

Patch Panels

Patch panels offer the most flexibility in a telecom closet. All incoming wires are terminated to the back of the patch panel on 110-style punchdowns (again watching the 1/2 inch limit of untwisting pairs). Then patch cables are used to interconnect the cables by simply plugging into the proper jacks.

Patch panels can have massive number of cables, so managing these cables can be quite a task in itself. It is important to keep all cables neatly bundled and labeled so they can be moved when necessary. However, it is also important to maintain the integrity of the cables, preventing kinking or bending in too small a radius which may adversely affect frequency performance.

(Note: Cat 6A cabling is physically larger in diameter than Cat 5e and usually has a separator for the pairs. The cable construction makes the cable stiffer and more prone to kinking, requiring a larger bend radius.)



Installing Wiring

Everybody knows how to pull wire, right? Wrong! Mistakes in installation work can be difficult to detect. A mistake that could keep the entire system from working might not show up at all until the system is completely installed and turned on.

The performance of the cabling network is heavily dependent on the installation. The components used in structured cabling installation have been carefully designed and exhaustively tested to meet or exceed the requirements of EIA/TIA 568 for performance at 100-250 MHz. If the cable is not properly installed,



Uncle Ted's Guide To VDV Cabling

performance will be degraded.

Just like we keep harping on keeping the twists right down to the terminations, there are things you must realize to maintain the performance of Cat 5e /6/6A wire you paid for! First of all, pulling tension must be less than 25 pounds. That's not very much! Pulling at higher tension can stretch the cable and affect the twists in the pairs, and it's those twists that make the cable perform well at high frequencies. Likewise, kinking the cable by letting it get twisted or pulled around sharp corners can cause permanent damage. Damaged cable will probably not pass crosstalk tests.

Most cable boxes are designed to allow easy pulling directly from the box. Gather up several boxes and pull a bunch of cables at once. Tape them together and attach a pullstring or just feed them along by hand.

You can pull from the telecom closet or to the closet, whichever is more convenient in the install you are doing. You can also pull to consolidation points then out to individual outlets or vice versa, instead of pulling the bundle of cables all the way.

One item to remember is there is usually 1,000 feet (about 300 meters) of cable in each box. Each cable is also marked with a distance every few feet so you can keep track of length by reading the distance off the cable. *Before you pull any cable from the box, find the distance marked on the cable and write it down on top of the box!* That way, you can calculate the length of each cable you pull and more importantly, the amount remaining in the box! It's not good to start pulling a cable and find out it's not long enough!

Likewise, mark every cable with a location it's going to. Mark it on both ends! You will save lots of time making the correct connections, recording test data and keeping records for moves and changes. A fine tip permanent marker will mark the cable neatly. Cat 5 e/6/6A should be installed on special hooks, bridle rings or cable trays that limit its bend radius and stress to preserve the performance. You cannot lay the cable on top of ceilings or hang from the drop ceiling hangers - most places it's against code! Penetrations of firewalls require firestopping to restore fire retardancy. You also have to keep the wire away from sources of interference, like fluorescent lights and power cables.

Safety

Power cables are also a safety hazard. Although this cable is called "low voltage," it runs in areas full of power cables that are a shock hazard. If you are not familiar with electrical safety, fire safety and inspections, I strongly suggest taking a course on the NEC (National Electric Code) to learn about these important topics. *It could save your life!*

Here is a summary of NEC references to VDV Cabling:

Chapter	Article	Topic
6	640	Sound Systems
7	725	Remote-Control, Signaling and Power-Limited Circuits
7	760	Fire Alarm Signaling Systems
7	770	Optical Fiber Cables and Raceways
7	780	"Smart House" Wiring
8	800	Telecommunications Circuits (Telephone and LAN)

Uncle Ted's Guide To VDV Cabling

8	810	Radio and TV Equipment
8	820	CATV Systems
8	830	Network-Powered Broadband Systems

Other safety considerations:

- Hard hat, safety glasses, appropriate gloves and steel toe shoes are recommended.
- Observe ladder safety rules - many installations require work above ceilings.

Inspection

Electrical inspectors do not always inspect communications wiring. Nonetheless, take a moment to check with local electrical inspectors before you do any work in their jurisdictions. In most cases, the inspector of your installation will be the same person who signs you contract, although in some cases, the inspector will be a third party. Make sure you know who will inspect your work before you give your customer a final price. You must know what the inspector will expect of you and what he or she will be looking for.

Installation Tips to follow:

- All components must be Cat 5e rated for Cat 5e performance (or Cat 6 or Cat 6A)
- Cable must be pulled from the reel or box without kinking
- Cable must be pulled with less than 25 pounds of tension
- Use cable lubricant in conduit if necessary
- Cable must not be pulled around sharp corners or kinked
- Inspect the cable routes for surfaces that may abrade the cable
- On riser installations (overhead installation), try to lower the cable down, not pull up
- Cables must be supported to prevent stress. Cable supports should not have sharp edges that may distort the cable
- Cable ties must not be so tight as to distort the jacket of the cable. They are only used to prevent unnecessary movement of the cable, so snug is tight enough.

Testing Wiring

Since Cat 5e/6/6A cable is used to the fullest extent of its performance envelope, testing is very important. There are three basic tests that are called for as part of the EIA/TIA specs for all UTP cables: wiremap, length and high speed performance. Let's take a look at each of them.

What Is A "Certified" Cable?

Certification is one of the most overused and least understood words in our industry! Did the cable pass an exam and get a certificate? Well, sort of. This term has been used by vendors of testers to mean that the cable was tested and passed by one of the Cat 5e/6/6A "certification" testers which test all the standard's specified performance parameters. It means that the cabling meets the minimum specifications of EIA/TIA standards and should work with any network designed to operate on a Cat 5e/6/6A link.

Length

Since 568 cables must be less than 90 meters (296 feet) in the link and 100 meters in

Uncle Ted's Guide To VDV Cabling

the channel (328 feet), length must be tested. This is done with a "time domain reflectometer" which is a fancy term for cable "radar". The tester sends out a pulse, waits for an "echo" from the far end and measures the time it took for the trip. Knowing the speed in the cable, it calculates the length. All cable certification testers include a TDR to measure length.

If you have a short or open, the TDR will also tell you where the problem is, making it a great tool for troubleshooting problems.

Wiremap

Wiremapping simple means that each wire is hooked up correctly, with no opens or shorts. That's mostly very straightforward. Each pair must be connected to the correct pins at the plugs and jacks, with good contacts in the terminations.

Most of the wiremap failures are simple enough to understand, like reversed wires in a pair, crossed pairs, opens or shorts. One possible failure, crossed pairs, is caused when both wires of a pair are crossed at one termination. The usual cause of a crossed pair is a 568A termination on one end and a 568B on the other.

The most difficult wiremap problem is a split pair, when one wire on each pair is reversed on both ends. It causes the signal to be sent on one wire each of two pairs. The usual DC wiremap will pass but crosstalk will fail. It takes a more sophisticated wiremapper or Cat 5e/6/6A tester to find a split pair, as some wiremappers which use only DC tests do not check crosstalk. In our experience, a split pair is usually caused by someone using punchdown color codes on jacks which splits the pairs.

Wiremap For T568B*

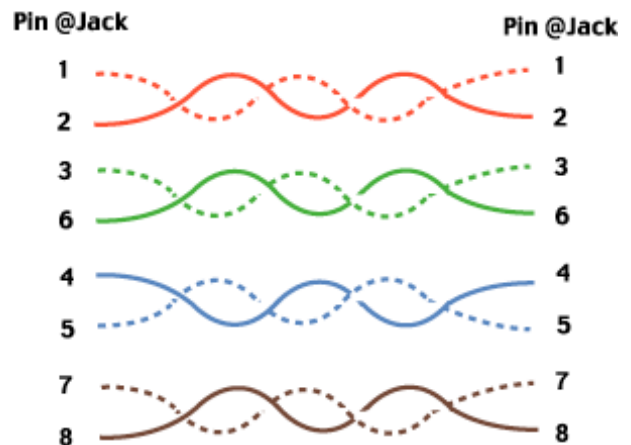

***T568A reverses orange & green pairs**

Attenuation

The proper operation of a LAN on the cable plant requires the signal strength be high enough at the receiver end. Thus the attenuation of the cable is very important. Since LANs send high speed signals through the cable and the attenuation is variable with the frequency of the signal, certification testers test attenuation at several frequencies specified in the 568 specs.



Uncle Ted's Guide To VDV Cabling

This test requires a tester at each end of the cable, one to send and one to receive, then one of them will calculate the loss and record it. There are pass fail criteria for the cable at specified maximum frequencies.

Crosstalk (NEXT)

It's called NEXT for "near end cross talk" since it measures the crosstalk (signal coupled from one pair to another) at the end where one pair is transmitting (so the transmitted signal is largest causing the most crosstalk.) Crosstalk is minimized by the twists in the cable, with different twist rates causing each pair to be antennas sensitive to different frequencies and hopefully not picking up the signals from it's neighboring pairs.

Remember what we've said repeatedly: *you MUST keep the twists as close to the terminations as possible to minimize crosstalk.*

Cat 5e /6 testers measure crosstalk from one pair to all three other pairs for each pair and compare it to the 568 specs, giving a pass/fail result. Some also calculate "ACR" or attenuation/crosstalk ratio, as it is a measure of how big the crosstalk signal is to the attenuated signal at the receiver. You want this number as big as possible, as it is an indication of the signal to noise ratio.

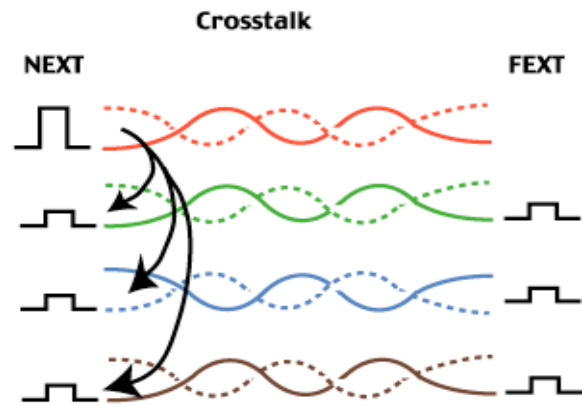

More Tests for Gigabit Ethernet

The latest generation of test specs for Category 5e and 6 includes a number of new tests to insure higher performance from the cable. These tests relate to higher bandwidth usage of the cable and simultaneous use of all four pairs, even in both directions at once.

Powersum NEXT is the NEXT on one pair when all three others are carrying signals. This is realistic with 1000Base-T Gigabit Ethernet where all pairs carry signals simultaneously.

Far end crosstalk, looking at the effect of the coupling from one pair to another over the entire length, measured at the far end. As tested, it's **ELFEXT** or equal level FEXT, or the ratio of FEXT to attenuation, sort of like ACR.

Delay Skew measures how much simultaneous pulses on all 4 pairs spread out at the far end. This measures the speed on each pair, which may be different due to the variations in number of twists (more twists means longer wires) or insulation. Since 1000Base-T Gigabit Ethernet uses all 4 pairs with the signals split into 4 separate signals, it's necessary to have all arrive simultaneously. Testers measure **Propagation**

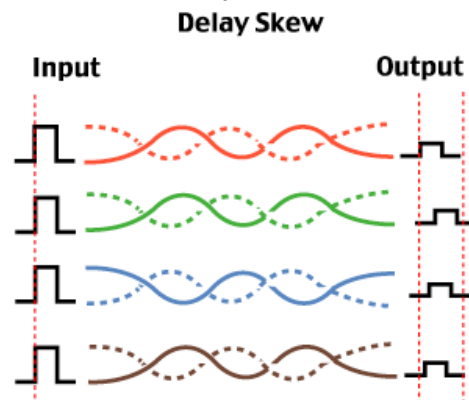

Uncle Ted's Guide To VDV Cabling

Delay, the actual transit time on the pairs to calculate Delay Skew.

Return Loss is a measure of the reflections from the cable due to variations in the impedance. These reflections can cause signal degradation, especially if the pairs are used in a full-duplex (bidirectional) mode. With 1000Base-T Gigabit Ethernet transmitting in both directions on each pair, return loss can cause big problems.

Testers

Wiremappers test the connections, verifiers test with network data and Cat 5e/6/6A certification testers test the performance at high frequencies. Cable Certification testers are the most widely used and accepted. They are mostly automated, "push a button get a pass/fail" simple. In fact, certification testers test everything, wiremap, length, attenuation and crosstalk in one connection, give you a pass/fail result, help on troubleshooting and store the result for printing reports for the customer.

Some installers use the certification tester for all testing, after the cable is installed. But it's a very expensive unit that needs a trained operator and many failures are simply wire map problems. Others have each crew use an inexpensive wiremapper to make sure all connections are correct before the certification tester is brought in. By having each crew find and fix their own wiremap problems, testing and corrections are done as the cable is installed and the cost of the certification tester is not wasted on simple problems. It's just provides the high frequency tests and documentation required by most users.

Permanent Link Adapters

The tester's adapter interface cable may be the weakest link when testing. Conventional

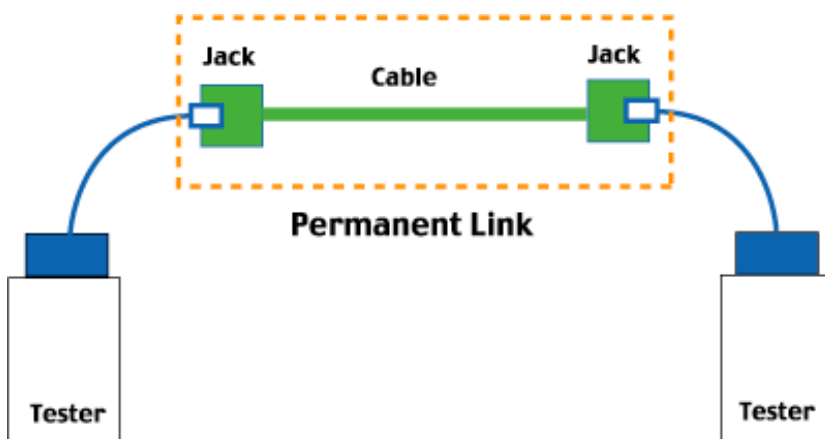

adapter cords may be the cause for many false failures in the field. Susceptible to the daily wear and tear associated with rough field conditions, they degrade with time and contribute to return loss.

A change in the definition of the "link" has been implemented in EIA/TIA568 B and ISO 11801 AM2 and it is now called the "permanent link." The permanent link moves the test reference point to the end of the test cable at the wall outlet or patch panel jack,

Uncle Ted's Guide To VDV Cabling

including only the connector on the end of the tester interface cable. Compliance with this standard could speed compatibility among Cat 6 cabling systems.

Wrap-up

Who Cares About Cabling?

The typical buyer of a cabling system is an IT (information technology) or network manager. Cabling represents only a few percent of their budget, yet it may cause half their problems! Think about all the things they have to worry about:

- Cabling
- Network equipment (hubs, switches, routers, NIC cards)
- PCs
- Software - licenses, upgrades, etc.
- User training
- Security – spam, viruses, worms and hackers

What the IT manager wants is cabling that is installed on time and works properly at a reasonable cost. Over the lifetime of their network, they may spend several times the original cost in MACs (moves, adds and changes). It's important to remember that they are looking for professionalism not price!

Manufacturers' Warranties

Most cabling system manufacturers offer long warranties on the performance of their cabling. In order to qualify for these warranties, you must use all their products or products they have approved and it must be installed by one of their certified installers.

How Long Is A "Lifetime Warranty" Good For?

At one of our Cable U Conferences, we had a session on manufacturers certification and warranties. Manufacturers of cabling products offer warranties of 15-25 years or even lifetime warranties if the cabling uses their components and is installed by one of their certified installers. What does this mean?

Many users think it means the manufacturer and installer guarantee the cable plant they have installed will support their network needs for that length of time. NO WAY! It means the cable plant will still meet Cat 5 /5e/6 performance limits over that period of time. Assuming you could find a working Cat 5/5e tester in 2013 (anybody starting a Structured Cabling Museum?), the cable would still have to pass Cat 5 /5e requirements according to the warranty.

The only cable plant warranty that makes sense is the "Lifetime Warranty," since the lifetime of any cable you install today is highly unlikely to last longer than 5 years!

Get Trained Properly Before You Start

The most important part of getting started in data/voice/video cabling installations is getting trained. The oft-quoted statistic that 80% of all Cat 5/5e installations would not pass standard specs is a result of too many installers working without proper training.

Uncle Ted's Guide To VDV Cabling

Maybe some have installed telephone wiring successfully for years, but unless they follow the standards and use proper installation and termination procedures, they will ruin the performance of the cabling they install.

We suggest you read everything you can about cabling. Of course we recommend our book [Data, Voice and Video Cable Installation](#).

This guide is another recommendation, of course, but there is no substitute for good hands-on training. [VDV Works](#) offers its VDV Academy at the annual VDV Expo sponsored by NECA but there are lots of other good trainers who will bring a complete training program to your company. [Contact us for some suggestions.](#)

Tools and Test Equipment

Many years involvement in the cabling business and training installers have left us with some strong opinions on tools and test equipment. Let's list them:

Buy the best tools you can afford. They will last longer and cost less in the long run.

Try them before you buy them to see if you like how they work.

Check them out before you go out on a job. Make sure all the tools are in good shape, you have all the accessories you will need, testers have fresh batteries or a recharge, and make sure you remember how to use everything.

After the job is finished, check everything again, replace or fix whatever needs replacing or fixing, before you take your kit back in the field.

Good installing!

The Fiber Optic Association, Inc.

1-760-451-3655 Fax 1-781-207-2421

www.foa.org info@foa.org

